

poufmania[®]
.com

get into joy!



Contents

PRODUCTS

funky	4
cookie	9
sunset	10

DIMENSIONS	12
------------	----

FABRICS GUIDE	18
---------------	----

Brochure concept and design: Fish Communications
Styling: Hara Kontaxaki - www.boxesnfoxes.gr
Photos: Studio Koukos

Photoshooting executed at Kanelli's flagship showroom.
We would like to thank Kanelli company (www.kanelli.eu) for their fruitful contribution.





FUNKY 3seat sofa



FUNKY 2seat sofa



FUNKY corner



FUNKY corner



FUNKY seat + pouf



COOKIE



SUNSET 140 + pouf



SUNSET 120 + pouf

FUNKY 3seat sofa



FUNKY 2seat sofa



***Funky sofas consist of:**
• 2 funky corners
• 1 funky seat (for 3seat sofa)

FUNKY corner



FUNKY pouf



Funky 95x95x90/42

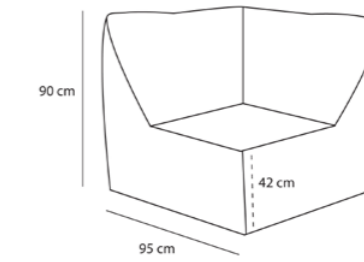

Funky 85x85x80/40

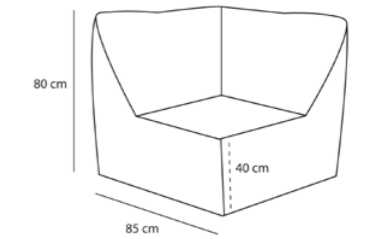

Funky pouf 95x95/40

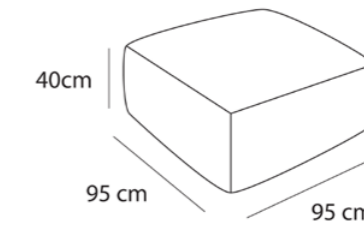

Funky pouf 85x85/40

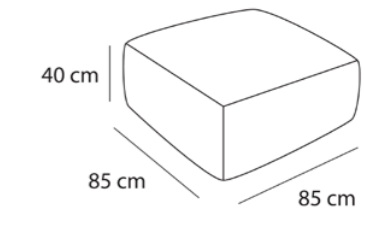

DIMENSIONS

FUNKY pouf



Funky pouf 68x45/40

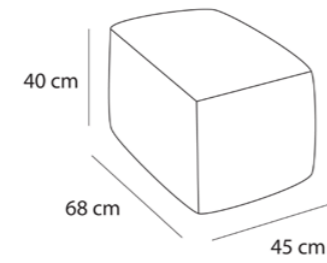

FUNKY seat



Funky 85x75x80/40

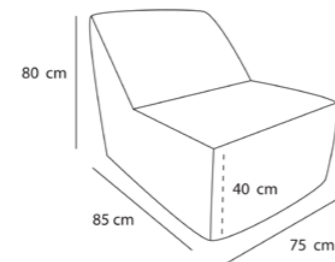

Funky 95x68x90/42

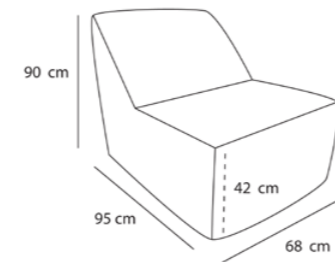

COOKIE



Cookie 115 Ø x 75/30

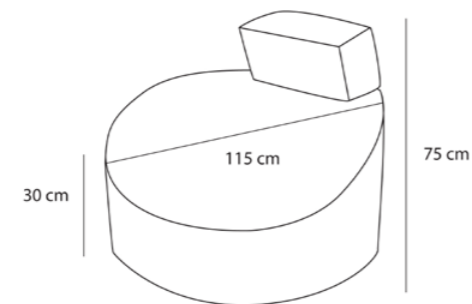

DIMENSIONS

SUNSET 140 + pouf



Sunset 140x110x110/40

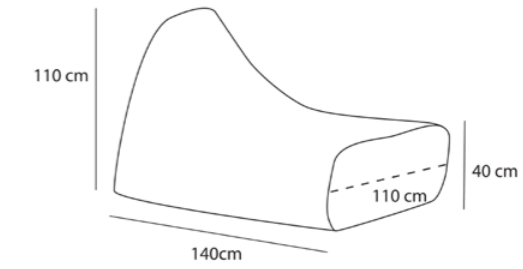

Sunset pouf 45x110/40

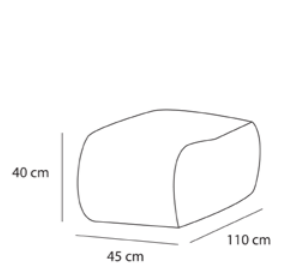

SUNSET 120 + pouf



Sunset 120x90x90/30

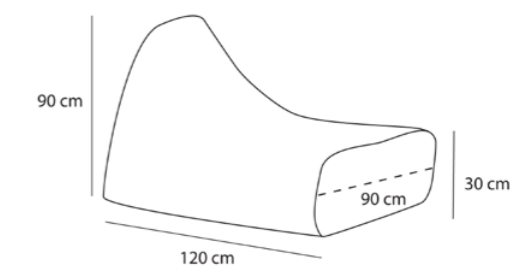

Sunset pouf 40x90/30

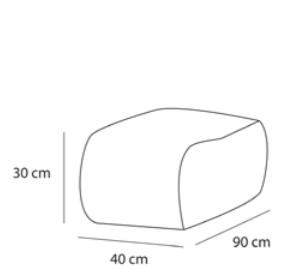

BINGO double



Bingo 160x150x80/30

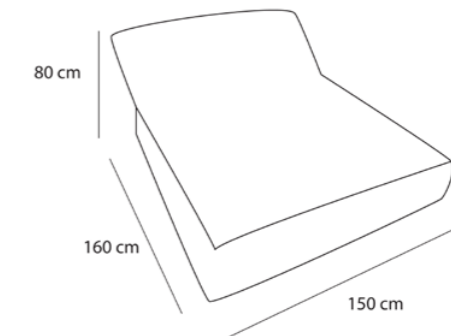

DIMENSIONS

BINGO 180x70x80/30 cm



Bingo 180x70x80/30

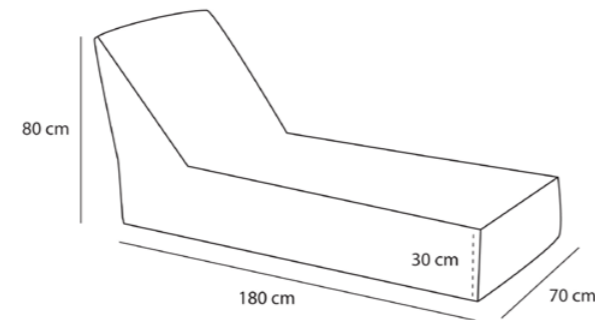

BINGO 120x90x80/30 cm



Bingo 120x90x80/30

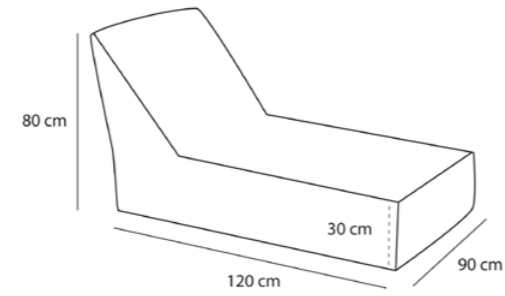

BINGO double pouf



Bingo 160x50/30

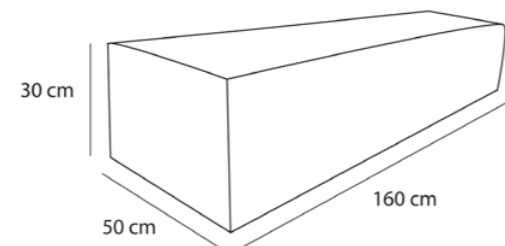

BINGO pouf



CLASSIC



Bingo 50x90/30

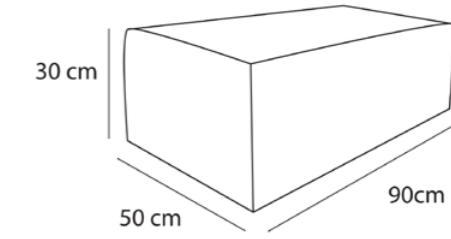

Bingo 50x70/30

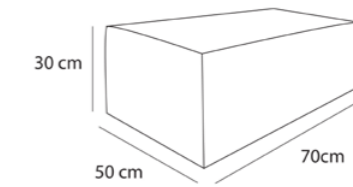

Classic 145 Ø

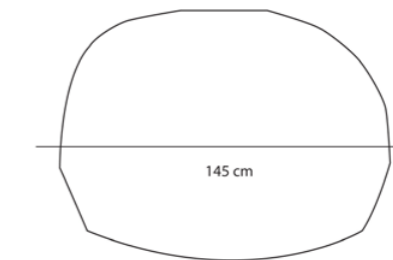

Classic 125 Ø

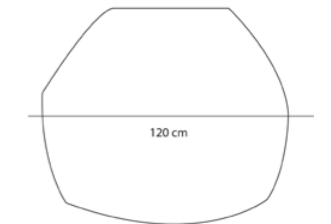

COOKIE MARINE



Cookie 115 Ø x 75/30

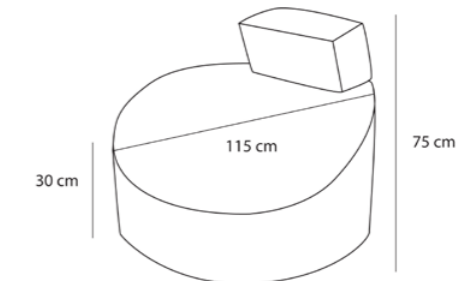

DIMENSIONS









FABRICS GUIDE

INDOOR

- ALONSO
- DENIM
- FLORIDA
- GONZALEZ
- HAMILTON
- TANZANIA

INDOOR & OUTDOOR

- DICKSON
- SUNBRELLA
- WIND
- YACHT

-  Breathable
-  Cotton
-  Fire Retardant
-  Hand Wash
-  Polysterene
-  Sunbrella Acrylic
-  UV Resistant
-  Washable
-  Water - repellent

ALONSO



Cover:
 •100% polystyrene • Seam slippage resistance • Abrasion resistance • Limited absorption of liquid spills
Care:
 •The outer cover is washable at low temperature (max 30°C) • Do not tumble dry



DENIM



Cover:
 •85% cotton & 15% polystyrene • Pre-washed • Tear resistance • Limited absorption of liquid spills
Care:
 •The outer cover is washable at low temperature (max 30°C) • Do not tumble dry



DICKSON



Cover:
 •100% Acrylic • Water-repellent • UV Resistant note 7-8 • Tear resistance • 5 years Guarantee • Chlorine resistant
Care:
 •The outer cover is washable at low temperature (max 30°C) • Do not tumble dry



FLORIDA



Cover:
 •74% PVC 4% PU 14% polyester • 8% cotton • Tensile strength • Tear strength • Seam slippage resistance
 • Color fastness to light / rubbing • Abrasion resistant • Fire retardant
Care:
 •Hand Wash – Stains clean with neutral soap foam.

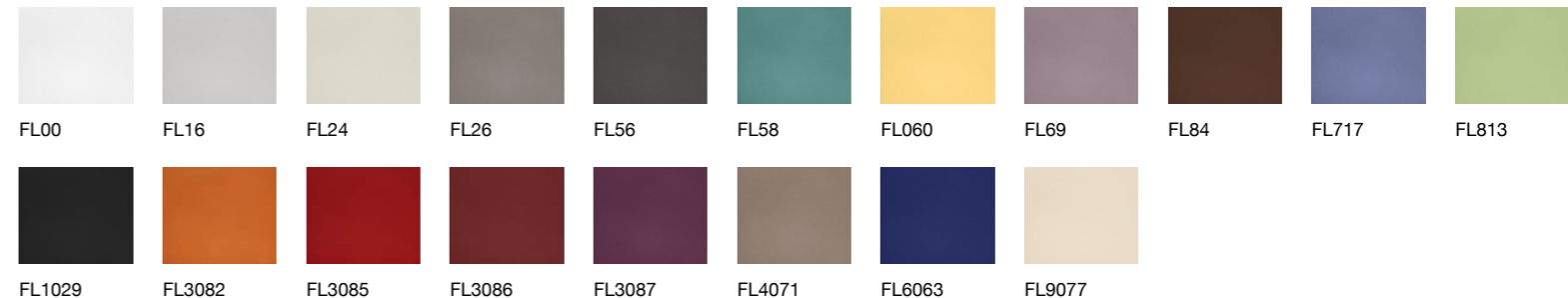

GONZALEZ



Cover:
 •100% polystyrene • Seam slippage resistance • Abrasion resistance • Soft touch

Care:
 •The outer cover is washable at low temperature (max 30°C) • Do not tumble dry



HAMILTON



Cover:
 •100% polystyrene • Seam slippage resistance • Abrasion resistance • Limited absorption of liquid spills • Easy cleaning

Care:
 •The outer cover is washable at low temperature (max 30°C) • Do not tumble dry



SUNBRELLA



Cover:
 •100% Sunbrella Acrylic • UV Resistant note 7-8 • Water – Repellent • Stain proof • Breathable • Mold Resistant • Chlorine resistant • 5 years Guarantee

Care:
 The outer cover is washable at low temperature (max 30°C)

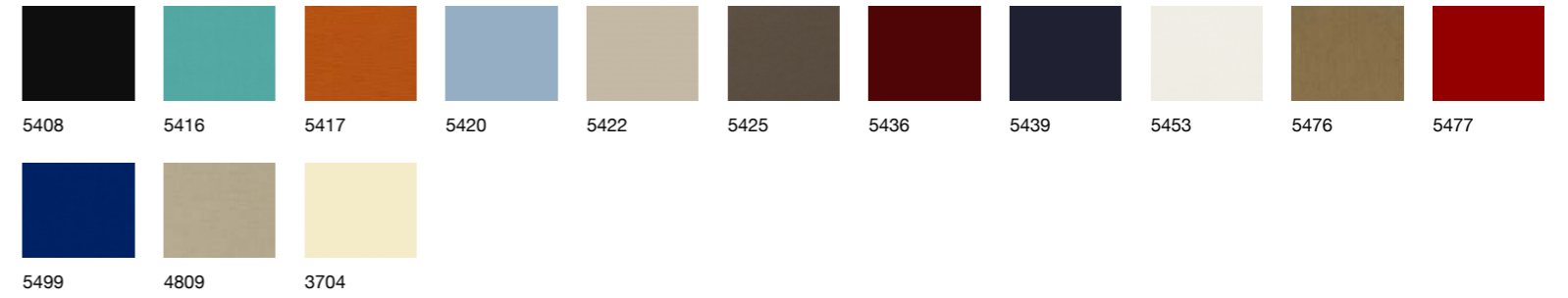
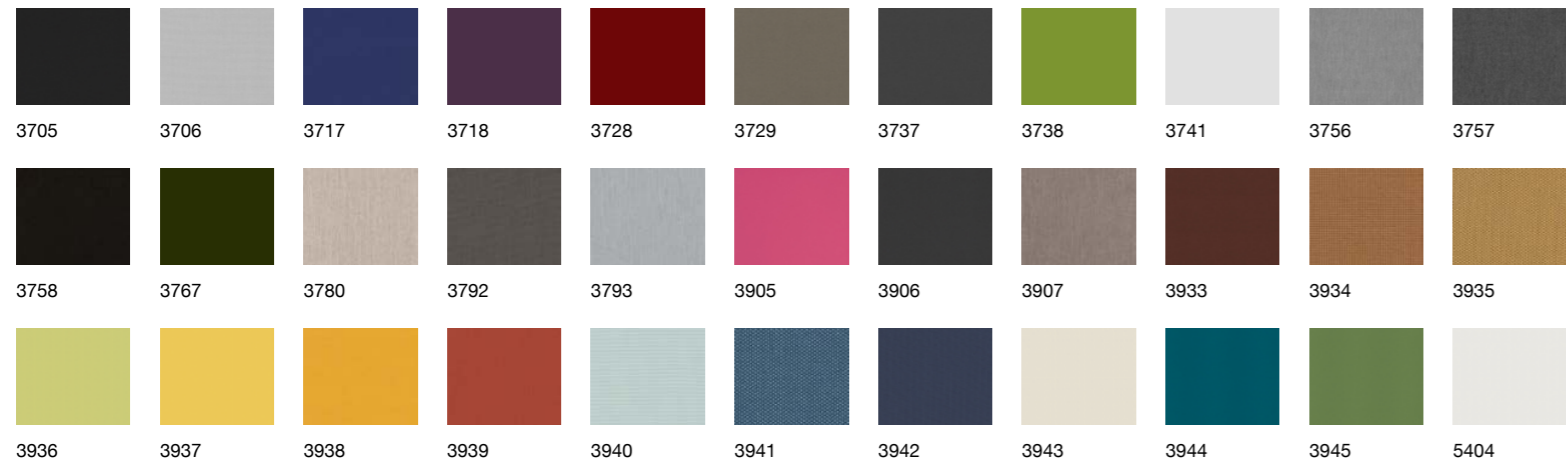

TANZANIA



Cover:
 •100% PP • Seam slippage resistance • Abrasion resistance • Anti-bacterial • High resistance to fungi & mould

Care:
 •The outer cover is washable at low temperature (max 30°C) • Do not tumble dry



WIND



Cover:
 •95% PVC 5% PU • Waterproof • Tensile strength • Tear strength • Seam slippage resistance • Abrasion resistant • Color fastness to light / rubbing • Mildew resistant

Care:
 Hand Wash – Stains clean with neutral soap foam.



YACHT



Cover:
 •11% Polyester 1% PU 88% PVC • Color resistance to light • Color resistance on water containing chlorine • Color resistance on sea water • Abrasion resistant • Tear resistance • Tensile strength • Elongation

Care:
 Hand Wash – Stains clean with neutral soap foam. If stains persist continue with 20% alcohol.





SPECIALISTS IN

CONTRACT PROJECTS



pouf  **mania**[®]
.com

7 Ilioupoleos str, Athens - Greece
P.C. 116 31
T / F: +30 210 4838324-5
info@poufomania.com
www.poufomania.com